

F385A e-dynamic
F385RA e-dynamic

lbs/ft

F385A e-dynamic

F385RA e-dynamic



CRANESWITHOUT COMPROMISE

US

F385A e-dynamic

LIFTING CAPACITY:

up to 271599 lbs.ft

MAX OUTREACH:

up to 93'11" ft with jib

OVERALL DIMENSIONS:

l 4'4" ft , w 8'3" ft , h 7'11"ft

ELECTRONIC/HYDRAULIC EQUIPMENT

FX800 control unit

D850 digital distributor bank

RCH/RCS radio remote control unit

ADC automatic dynamic control

flow sharing

CHARACTERISTICS:

Dynamic version (.2): with linkage

ProLink system with double linkage

rotation 430° with rack and pinion

FR

F385A e-dynamic

CAPACITÉ DE LEVAGE:

jusqu'à 271599 lbs.ft

BRAS HYDRAULIQUE:

jusqu'à 93'11" ft avec jib

ENCOMBREMENT GRUE:

l 4'4" ft , w 8'3" ft , h 7'11"ft

ÉQUIPEMENT ÉLECTRONIQUE/HYDRAULIQUE:

unité de contrôle FX800

distributeur hydraulique digital D850

unité de commande radio RCH/RCS

contrôle de la dynamique ADC

flow sharing

CARACTÉRISTIQUES:

version dynamic (.2): avec bielle

système ProLink avec double bielle

rotation 430° avec crémaillère et pignon

ES

F385A e-dynamic

POTENCIA DE ELEVACIÓN:

hasta 271599 lbs.ft

MÁXIMO ALCANCE HIDRÁULICO:

hasta 93'11" ft con jib

EMBARAZADO GRÚA:

l 4'4" ft , w 8'3" ft , h 7'11"ft

DOTACIÓN

ELECTRÓNICA/HIDRÁULICA:

unidad de control FX800

distribuidor hidráulico digital D850

unidad de mando radio RCH/RCS

dispositivo control dinámico ADC

flow sharing

CARACTERÍSTICAS:

versión dynamic (.2): con sistema de bielas

sistema ProLink y doble mecanismo

The images are sole purpose of presentation of the product - Les images sont à seule fin de la présentation du produit - Las imágenes son solo propósito de la presentación del producto



US

F385RA e-dynamic

LIFTING CAPACITY:

up to 280206 lbs.ft

MAX OUTREACH:

up to 88'5"ft with jib

OVERALL DIMENSIONS:

l 4'9" ft , w 8'3" ft , h 8'0" ft

ELECTRONIC/HYDRAULIC EQUIPMENT:

FX800 control unit

D850 digital distributor bank

RCH/RCS radio remote control unit

ADC automatic dynamic control

flow sharing

CHARACTERISTICS:

Dynamic version (.2): with linkage

ProLink system with double linkage

continuous rotation on a slew ring

FR

F385RA e-dynamic

CAPACITÉ DE LEVAGE:

jusqu'à 280206 lbs.ft

BRAS HYDRAULIQUE:

jusqu'à 88'5"ft avec jib

ENCOMBREMENT GRUE:

l 4'9" ft , w 8'3" ft , h 8'0" ft

ÉQUIPEMENT ÉLECTRONIQUE/HYDRAULIQUE:

unité de contrôle FX800

distributeur hydraulique digital D850

unité de commande radio RCH/RCS

contrôle de la dynamique ADC

flow sharing

CARACTÉRISTIQUES:

version dynamic (.2): avec bielle

système ProLink avec double bielle

rotation continue sur couronne dentée

ES

F385RA e-dynamic

POTENCIA DE ELEVACIÓN:

hasta 280206 lbs.ft

MÁXIMO ALCANCE HIDRÁULICO:

hasta 88'5"ft con jib

EMBARAZADO GRÚA:

l 4'9" ft , w 8'3" ft , h 8'0" ft

DOTACIÓN ELECTRÓNICA/HIDRÁULICA:

unidad de control FX800

distribuidor hidráulico digital D850

unidad de mando radio RCH/RCS

dispositivo control dinámico ADC

flow sharing

CARACTERÍSTICAS:

versión dynamic (.2): con sistema de biela

sistema ProLink y doble mecanismo a biela

rotación continua sobre corona

The images are sole purpose of presentation of the product - Les images sont à seule fin de la présentation du produit - Las imágenes son solo propósito de la presentación del producto



F385
Gallery







US ROTATION

Rack rotation with self-centering cast iron wear pad: it ensures the correct and constant coupling between the pinion and the rack, avoiding the wear and tear of the teeth.

FR ROTATION

Rotation à crémaillère avec patins en fonte autocentrants : ils garantissent un couplage correct et constant entre le pignon et la crémaillère permettant ainsi d'éviter l'usure des dents.

ES ROTACIÓN

Rotación de cremallera con patines de fundición autocentrados: garantizan un acoplamiento constante y correcto entre el piñón y la cremallera, evitando el desgaste de los dientes.

US

Features

BASE - Base and lower part of the column in cast steel for perfect stress distribution and greater resistance. The absence of welding ensures that the crane offers excellent characteristics of durability to fatigue.

BOOMS GUIDE - Extension booms guide shoes, with "forced" assembly to reduce vertical and horizontal clearance, ensuring greater durability. Special guide shoes material with high sliding degree and low greasing request.

TANK - Plastic tank, particularly resistant to shocks and the corrosive action of any external element.

LUBRICATION SYSTEM - Centralised lubrication system of the base to guarantee easier access for maintenance and control operations.

OUTRIGGER - Hydraulically extendable outriggers also in "Extra wide" execution, with jointed outrigger rams plate and hoses fitted inside the stabiliser supports. Independent hydraulic distributor for the control of the outriggers; it can be also activated by radio control (option). Available as option manual or hydraulic tiltable outriggers.

VERSION C - Crane version with a shorter secondary arm, to allow a greater height of under-hook lifting. Offers the possibility to lift especially bulky and heavy loads vertically, near the column of the crane. Automatic hooking system for the positioning of the extension booms in transport position when crane is folded behind cab.

Optional

WORKLIGHT - Powerful and versatile light that can be directed as required: helps you to work safely, even in conditions of poor natural light. Can be activated by means of the radio remote control pushbuttons.

JIB - Additional hydraulic articulation that allows you to increase the reach of the crane and, once the required height has been reached, to move the load horizontally in relation to the ground (without jeopardising the correct resting configuration of the crane). Exclusive Fassi Prolink system allowing to increase the working angle of the jib by 10 degrees above the horizontal line.

SEAT - Ergonomic, protected position to allow the operator greater control when carrying out specific movement and lifting operations. There are many possibilities of adjustments to find out the most comfortable working and control position and heated top seat as option.

SUPPLEMENTARY FUNCTIONS - Supplementary functions for the use of hydraulic accessories on the crane and the jib, protected by an exclusive Fassi system consisting of metal trays paired with highly resistant nylon guide-chains. High quality hoses resistant to the ozone action.

WINCH - Cable-operated lifting device equipped with an exclusive, patented mechanical, torque and end stop limiter system which avoids the risks resulting from direct and indirect overload applied to the winch itself. Anti-revolving cable and cable guide pulley to make easy the aligned winding of the cable on the winch drum.

FR

Caractéristiques

EMBASE - Embase et partie inférieure de la colonne en fusion d'acier pour une répartition optimum des sollicitations et pour une résistance supérieure. L'absence de soudures assure à la grue une longévité exceptionnelle.

PATINS DE GUIDAGE - Patins de guidage sur les bras d'extension, à montage "forcé" afin de réduire les jeux verticaux et latéraux prolongeant ainsi la durée de vie de l'ensemble. Patins en matériel spécial avec un degré de glissement élevé et demande réduite d'engraissage.

RÉSERVOIR - Réservoir en matière plastique très résistant aux chocs et à l'action corrosive de tout élément extérieur.

SYSTÈME DE LUBRIFICATION - Système de lubrification de l'embase centralisé pour garantir l'accès aux opérations d'entretien et de contrôle.

STABILISATEURS - Stabilisateurs à extension hydraulique disponible aussi en version "extra large", avec tuyauteries à l'intérieur du support des stabilisateurs (standard seulement sur version « dynamic »). Distributeur hydraulique dédié pour commande manuelle ou radio (en option) des stabilisateurs. Disponibilité comme option des stabilisateurs pivotants manuellement ou hydrauliquement.

VERSION C - Version de la grue avec un bras secondaire plus court, de manière à obtenir une hauteur sous crochet plus importante. Elle donne la possibilité de soulever verticalement, au plus près de la colonne de la grue, des charges très encombrantes et lourdes. Système d'accrochage automatique pour le positionnement des bras d'extension en position de transport avec grue repliée derrière cabine.

En option

PHARE DE TRAVAIL - Phare directionnel variable, puissant et adaptable, qui permet de travailler en toute sécurité même avec une mauvaise visibilité. Peut être activé avec les boutons de la radiocommande.

JIB - Articulation hydraulique supplémentaire permettant d'augmenter l'extension de la grue et, une fois la hauteur désirée atteinte, de déplacer la charge horizontalement par rapport au sol (sans intervenir sur la configuration initiale de la grue au repos). Système Prolink Fassi exclusif augmentant l'angle de travail des rallonges hydrauliques de 10 degrés au-dessus de la ligne horizontale.

SIÈGE - Poste ergonomique et protégé qui permet à l'opérateur un contrôle optimal lors d'opérations de déplacement et de levage spécifiques. Position de travail et des commandes réglable et option siège réchauffé.

TUYAUTERIES SUPPLÉMENTAIRES - Tuyauteries supplémentaires pour l'utilisation d'accessoires hydrauliques, sur grues et sur rallonges hydrauliques, protégées par un système exclusif Fassi se composant de supports en métal couplés à des chaînes de guidage en nylon à haute résistance. Tuyauteries flexibles de grande qualité résistantes à l'ozone.

TREUIL - Dispositif de levage par câble équipé du système exclusif breveté de limiteur de couple et de fin de course mécanique, évitant les risques de toute surcharge directe ou indirecte infligée au treuil. Câble anti-giratoire et poulie de guidage pour enroulement aligné et facilité du câble sur le tambour.

ES

Características

BASE - Base y parte inferior de la columna de fusión de acero para una distribución ideal de los esfuerzos y para una resistencia superior. La ausencia de soldaduras confiere a la grúa excepcionales características de resistencia a la fatiga.

PATINES DE GUÍA - Patines de guía de los brazos extensibles, con montaje "forzado" para reducir las holguras verticales y laterales, garantizando una vida útil más larga. Patines especiales con elevado grado de deslizamiento y baja necesidad de engrase.

DEPÓSITO - Depósito de material plástico especialmente resistente a los golpes y a la acción corrosiva de cualquier elemento externo.

SISTEMA DE LUBRICACIÓN - Sistema de lubricación centralizada de la base para garantizar un acceso más fácil en las operaciones de mantenimiento y control.

ESTABILIZADORES - Estabilizadores con extensión hidráulica también en versión "Extra extensible y cilindro estabilizador con piastra de apoyo articulada y tuberías al interior del soporte estabilizadores. Control con distribuidor hidráulico independiente, también por vía radio (option). Disponibilidad opcional de estabilizadores rotantes manual o hidráulico.

VERSIÓN C - Versión de grúa con un brazo secundario más corto, con el fin de permitir una mayor altura de elevación debajo del gancho. Ofrece la posibilidad de levantar en vertical, cerca de la columna de la grúa, cargas especialmente grandes y pesadas. Sistema de enganche automático para el posicionamiento de los brazos extensibles en posición de transporte con la grúa plegada detrás de la cabina.

Opcional

FARO PARA TRABAJO - Poderoso y versátil faro de dirección variable, ayuda a trabajar en seguridad, también en condiciones de iluminación escasa del ambiente. Se puede activar mediante el cuadro de pulsadores del radiocomando.

JIB - Articulación hidráulica adicional que permite aumentar el alcance de la grúa y, después de haberse alcanzado la altura deseada, desplazar la carga horizontalmente con respecto al terreno (sin perjudicar la prevista configuración en reposo de la grúa). Sistema exclusivo Prolink Fassi para aumentar el ángulo de trabajo de las prolongas hidráulicas por encima de la línea horizontal de 10 grados.

ASIENTO - Puesto ergonómico protegido para permitir al operario un mayor control en caso de operaciones específicas de manipulación y elevación. Posición de trabajo y de los mandos regulables y opción de asiento calefactado.

TUBERÍAS ADICIONALES - Tuberías adicionales para el uso de accesorios hidráulicos, en grúas y en extensiones hidráulicas, protegidas por un sistema Fassi exclusivo constituido por canaletas metálicas combinadas con cadenas de guía de nylon de alta resistencia. Tubos flexibles de alta calidad y resistentes a la acción del ozono.

CABRESTANTE - Dispositivo de elevación por cable equipado con un exclusivo sistema patentado de doble limitador final de carrera mecánico, que evita los riesgos que derivan de las sobrecargas directas e indirectas aplicadas sobre el propio cabrestante. Cable anti giro y polea guiada para rebobinado alineado al tambor.



US CONTINUOUS ROTATION

Continuous rotation with double roller and ball guide turntable and motoreducer.

FR ROTATION CONTINUE

Rotation continue sur couronne dentée à double guidage par roulements avec motoréducteur.

ES ROTACIÓN CONTINUA

Rotación continua en chumacera de doble circulación de bolas con motorreductor.

US

Features

BASE - Base with slots for tie rod fastening or for integrated counterframe allowing limitation of fitting height.

BOOMS GUIDE - Extension booms guide shoes, with "forced" assembly to reduce vertical and horizontal clearance, ensuring greater durability. Special guide shoes material with high sliding degree and low greasing request.

TANK - Plastic tank, particularly resistant to shocks and the corrosive action of any external element.

OUTRIGGER - Hydraulically extendable outriggers also in "Extra wide" execution, with jointed outrigger rams plate and hoses fitted inside the stabiliser supports. Independent hydraulic distributor for the control of the outriggers; it can be also activated by radio control (option). Available as option manual or hydraulic tilttable outriggers.

VERSION C - Crane version with a shorter secondary arm, to allow a greater height of under-hook lifting. Offers the possibility to lift especially bulky and heavy loads vertically, near the column of the crane. Automatic hooking system for the positioning of the extension booms in transport position when crane is folded behind cab.

Optional

WORKLIGHT - Powerful and versatile light that can be directed as required: helps you to work safely, even in conditions of poor natural light. Can be activated by means of the radio remote control pushbuttons.

JIB - Additional hydraulic articulation that allows you to increase the reach of the crane and, once the required height has been reached, to move the load horizontally in relation to the ground (without jeopardising the correct resting configuration of the crane). Exclusive Fassi Prolink system allowing to increase the working angle of the jib by 10 degrees above the horizontal line.

SEAT - Ergonomic, protected position to allow the operator greater control when carrying out specific movement and lifting operations. There are many possibilities of adjustments to find out the most comfortable working and control position and heated top seat as option.

SUPPLEMENTARY FUNCTIONS - Supplementary functions for the use of hydraulic accessories on the crane and the jib, protected by an exclusive Fassi system consisting of metal trays paired with highly resistant nylon guide-chains. High quality hoses resistant to the ozone action.

WINCH - Cable-operated lifting device equipped with an exclusive, patented mechanical, torque and end stop limiter system which avoids the risks resulting from direct and indirect overload applied to the winch itself. Anti-revolving cable and cable guide pulley to make easy the aligned winding of the cable on the winch drum.

FR

Caractéristiques

EMBASE - Embase avec oreilles de fixation et tirants ou par faux-châssis intégré limitant la hauteur de l'installation.

PATINS DE GUIDAGE - Patins de guidage sur les bras d'extension, à montage "forcé" afin de réduire les jeux verticaux et latéraux prolongeant ainsi la durée de vie de l'ensemble. Patins en matériel spécial avec un degré de glissement élevé et demande réduite d'engraissage.

RÉSERVOIR - Réservoir en matière plastique très résistant aux chocs et à l'action corrosive de tout élément extérieur.

STABILISATEURS - Stabilisateurs à extension hydraulique disponible aussi en version "extra large", avec tuyauteries à l'intérieur du support des stabilisateurs (standard seulement sur version « dynamic »). Distributeur hydraulique dédié pour commande manuelle ou radio (en option) des stabilisateurs. Disponibilité comme option des stabilisateurs pivotants manuellement ou hydrauliquement.

VERSION C - Version de la grue avec un bras secondaire plus court, de manière à obtenir une hauteur sous crochet plus importante. Elle donne la possibilité de soulever verticalement, au plus près de la colonne de la grue, des charges très encombrantes et lourdes. Système d'accrochage automatique pour le positionnement des bras d'extension en position de transport avec grue repliée derrière cabine.

En option

PHARE DE TRAVAIL - Phare directionnel variable, puissant et adaptable, qui permet de travailler en toute sécurité même avec une mauvaise visibilité. Peut être activé avec les boutons de la radiocommande.

JIB - Articulation hydraulique supplémentaire permettant d'augmenter l'extension de la grue et, une fois la hauteur désirée atteinte, de déplacer la charge horizontalement par rapport au sol (sans intervenir sur la configuration initiale de la grue au repos). Système Prolink Fassi exclusif augmentant l'angle de travail des rallonges hydrauliques de 10 degrés au-dessus de la ligne horizontale.

SIÈGE - Poste ergonomique et protégé qui permet à l'opérateur un contrôle optimal lors d'opérations de déplacement et de levage spécifiques. Position de travail et des commandes réglable et option siège réchauffé.

TUYAUTERIES SUPPLÉMENTAIRES - Tuyauteries supplémentaires pour l'utilisation d'accessoires hydrauliques, sur grues et sur rallonges hydrauliques, protégées par un système exclusif Fassi se composant de supports en métal couplés à des chaînes de guidage en nylon à haute résistance. Tuyauteries flexibles de grande qualité résistantes à l'ozone.

TREUIL - Dispositif de levage par câble équipé du système exclusif breveté de limiteur de couple et de fin de course mécanique, évitant les risques de toute surcharge directe ou indirecte infligée au treuil. Câble anti-giratoire et poulie de guidage pour enroulement aligné et facilité du câble sur le tambour.

ES

Características

BASE - Base con ojales para la fijación con tirantes o para contra bastidor integrado que permite la limitación de la altura de instalación.

PATINES DE GUÍA - Patines de guía de los brazos extensibles, con montaje "forzado" para reducir las holguras verticales y laterales, garantizando una vida útil más larga. Patines especiales con elevado grado de deslizamiento y baja necesidad de engrase.

DEPÓSITO - Depósito de material plástico especialmente resistente a los golpes y a la acción corrosiva de cualquier elemento externo..

ESTABILIZADORES - Estabilizadores con extensión hidráulica también en versión "Extra extensible y cilindro estabilizador con piastra de apoyo articulada y tuberías al interior del soporte estabilizadores. Control con distribuidor hidráulico independiente, también por vía radio (option). Disponibilidad opcional de estabilizadores rotantes manual o hidráulico.

VERSIÓN C - Versión de grúa con un brazo secundario más corto, con el fin de permitir una mayor altura de elevación debajo del gancho. Ofrece la posibilidad de levantar en vertical, cerca de la columna de la grúa, cargas especialmente grandes y pesadas. Sistema de enganche automático para el posicionamiento de los brazos extensibles en posición de transporte con la grúa plegada detrás de la cabina.

Opcional

FARO PARA TRABAJO - Poderoso y versátil faro de dirección variable, ayuda a trabajar en seguridad, también en condiciones de iluminación escasa del ambiente. Se puede activar mediante el cuadro de pulsadores del radiocomando.

JIB - Articulación hidráulica adicional que permite aumentar el alcance de la grúa y, después de haberse alcanzado la altura deseada, desplazar la carga horizontalmente con respecto al terreno (sin perjudicar la prevista configuración en reposo de la grúa). Sistema exclusivo Prolink Fassi para aumentar el ángulo de trabajo de las prolongas hidráulicas por encima de la línea horizontal de 10 grados.

ASIENTO - Puesto ergonómico protegido para permitir al operario un mayor control en caso de operaciones específicas de manipulación y elevación. Posición de trabajo y de los mandos regulables y opción de asiento calefactado.

TUBERÍAS ADICIONALES - Tuberías adicionales para el uso de accesorios hidráulicos, en grúas y en extensiones hidráulicas, protegidas por un sistema Fassi exclusivo constituido por canaletas metálicas combinadas con cadenas de guía de nylon de alta resistencia. Tubos flexibles de alta calidad y resistentes a la acción del ozono.

CABRESTANTE - Dispositivo de elevación por cable equipado con un exclusivo sistema patentado de doble limitador final de carrera mecánico, que evita los riesgos que derivan de las sobrecargas directas e indirectas aplicadas sobre el propio cabrestante. Cable anti giro y polea guiada para rebobinado alineado al tambor.





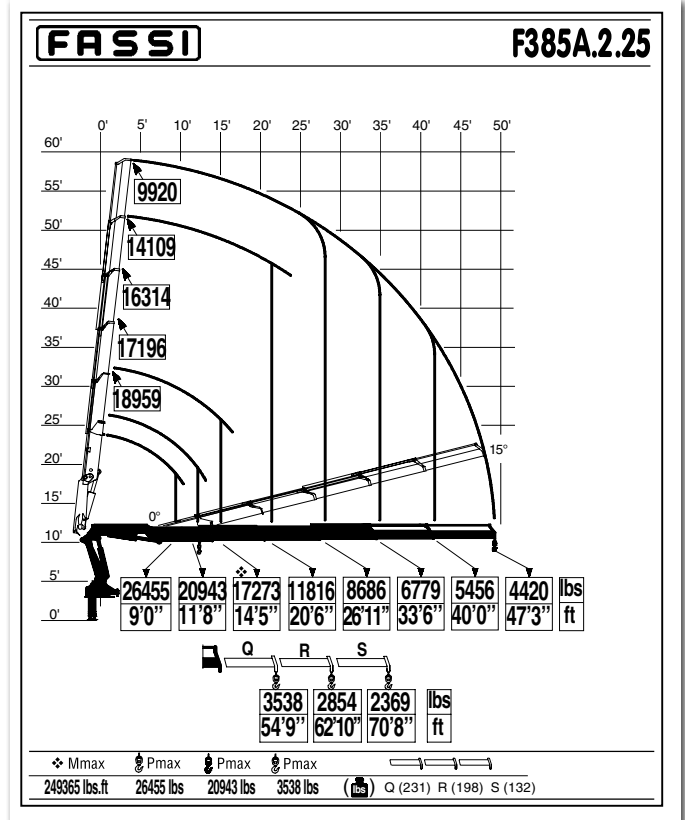
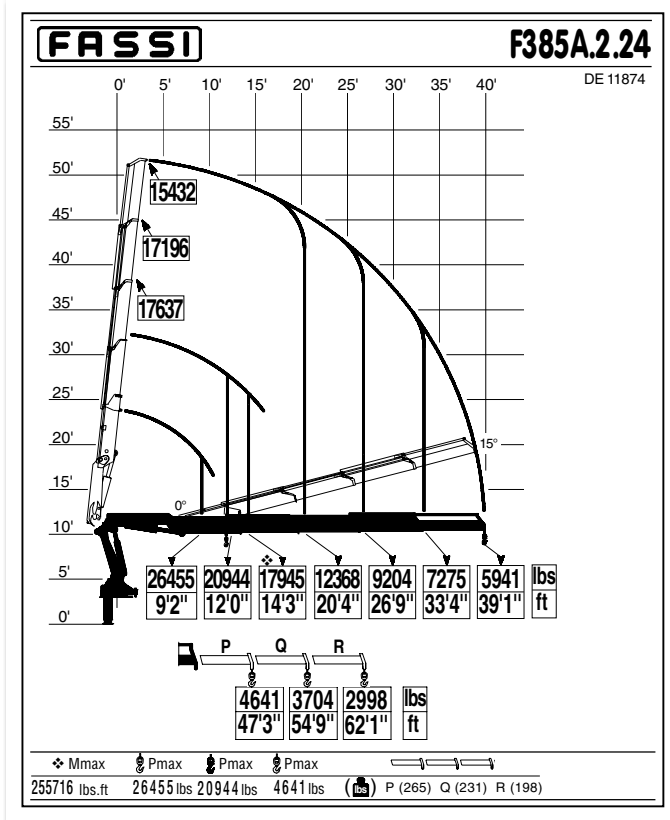
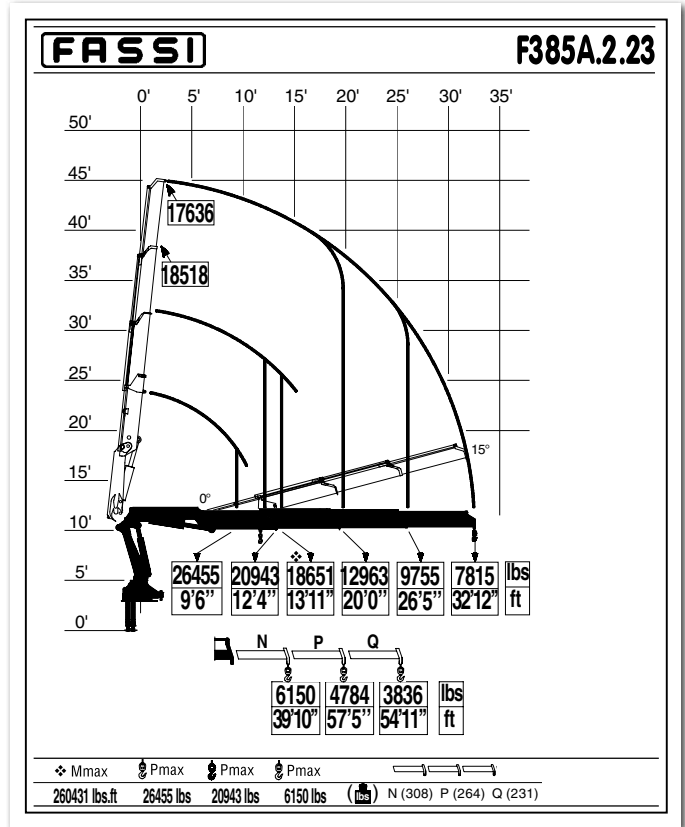
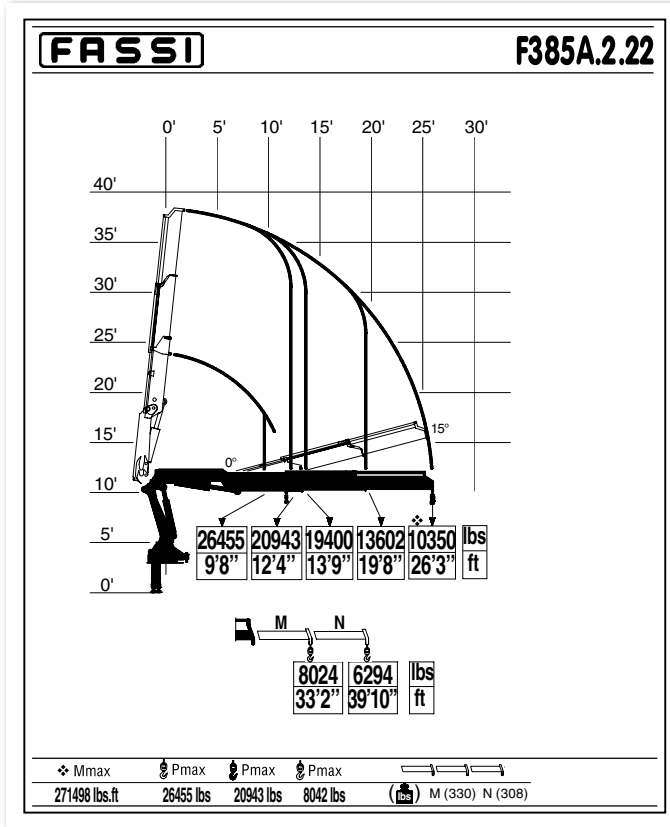

US Dynamic load diagrams calculated, tested and certified to lift the loads at the declared reaches

FR Diagrammes de charge dynamiques calculés, testés et certifiés pour soulever les charges aux extensions déclarées

ES Diagramas de carga dinámicos, calculados, probados y certificados para a elevación de la cargas a los alcances declarados

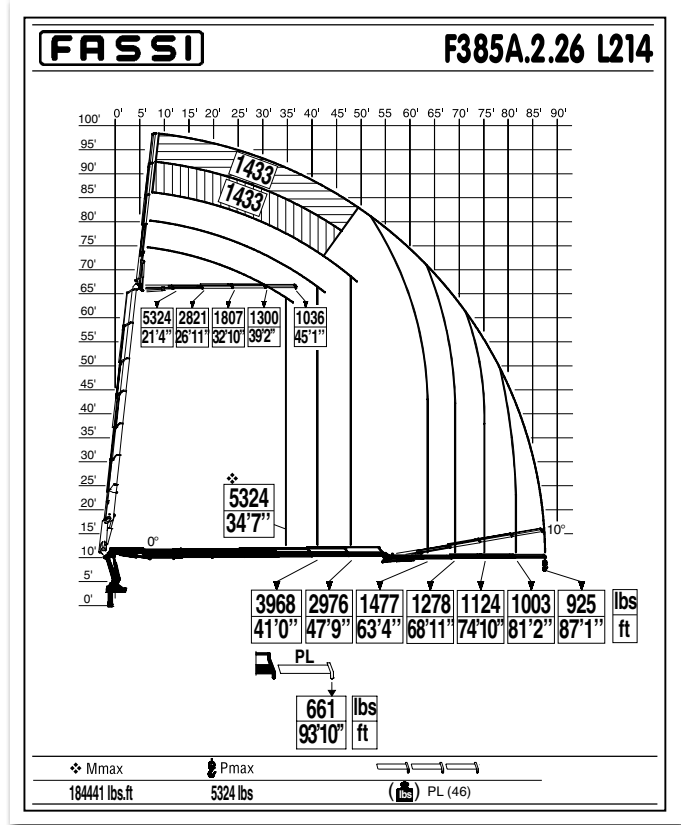
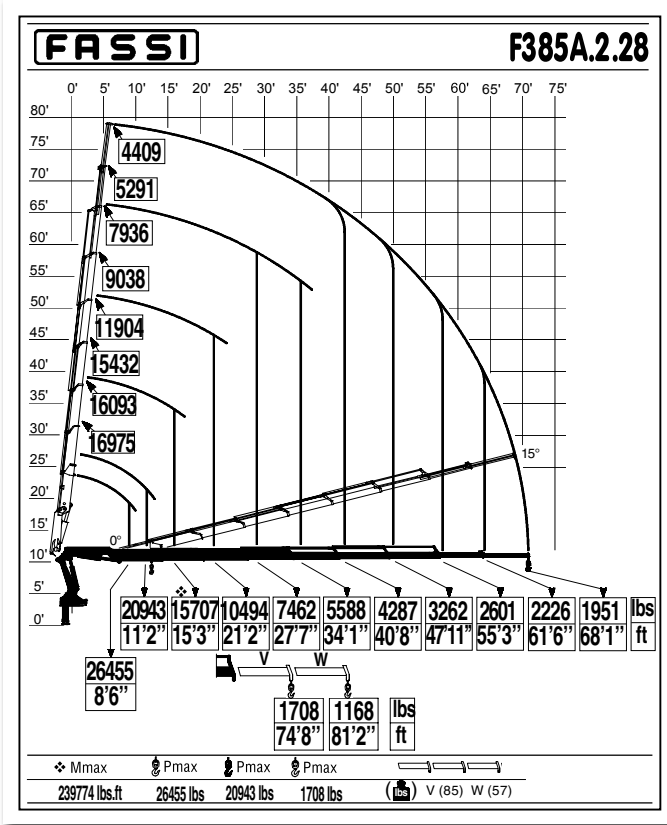
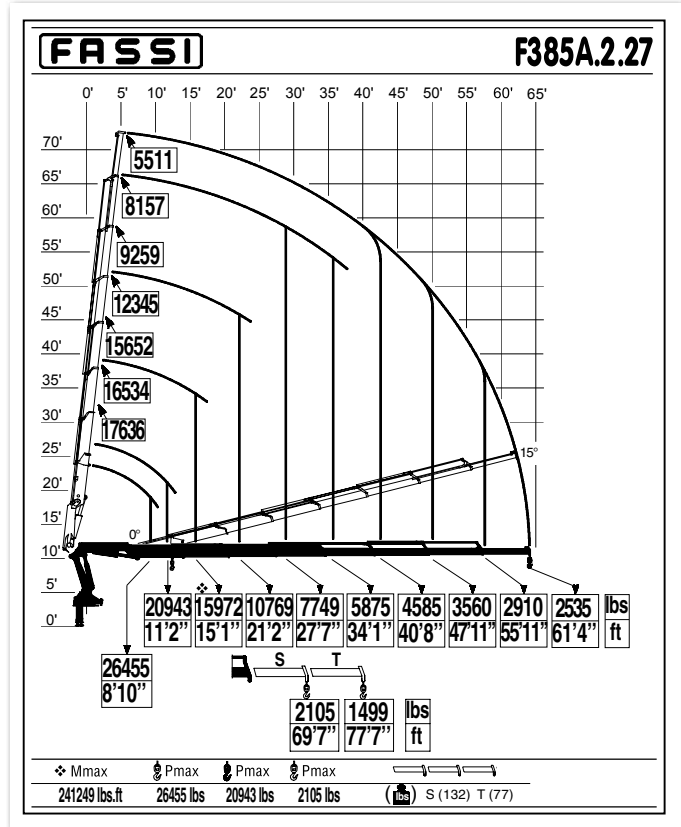
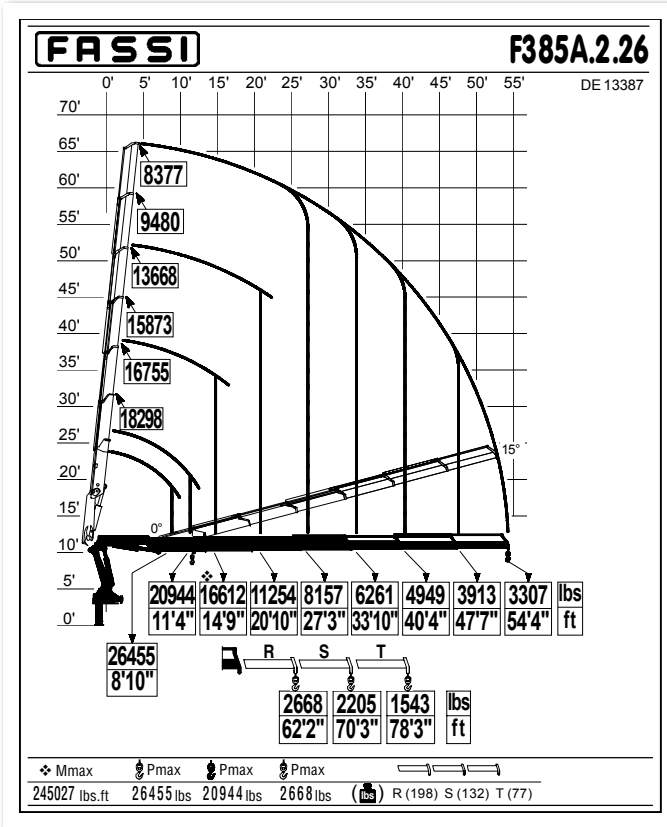

**CERTIFIED
DYNAMIC
PERFORMANCE**

- US Dynamic load diagrams calculated, tested and certified to lift the loads at the declared reaches
- FR Diagrammes de charge dynamiques calculés, testés et certifiés pour soulever les charges aux extensions déclarées
- ES Diagramas de carga dinámicos, calculados, probados y certificados para a elevación de la cargas a los alcances declarados

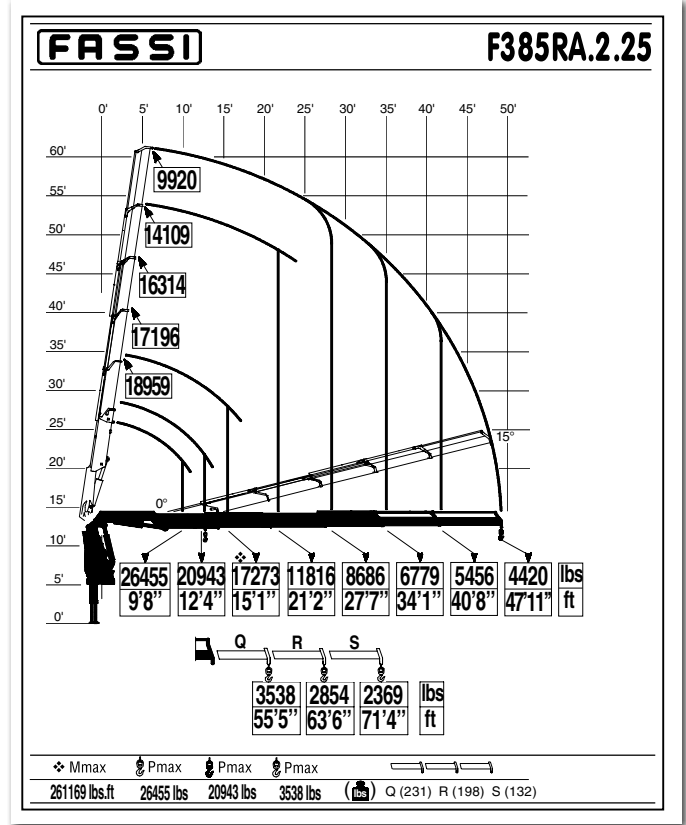
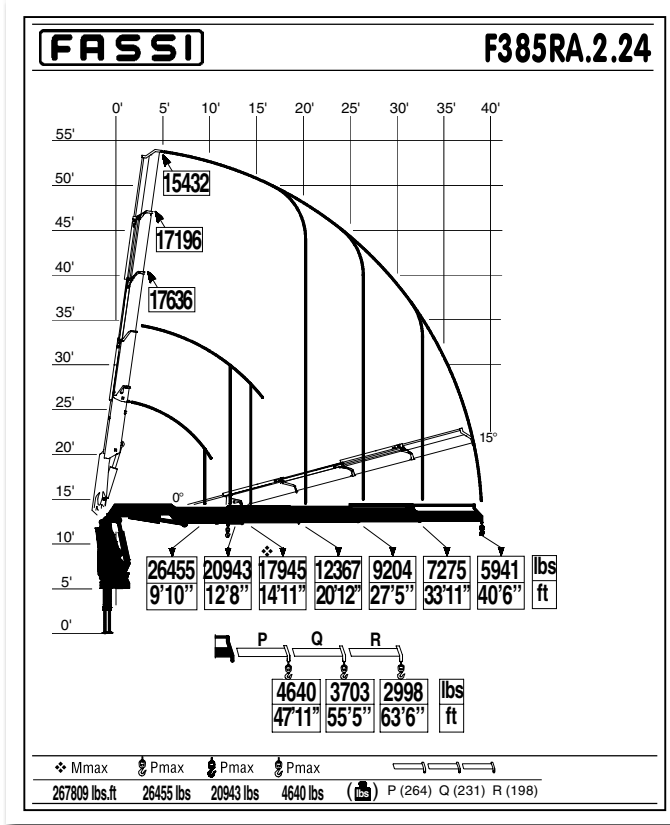
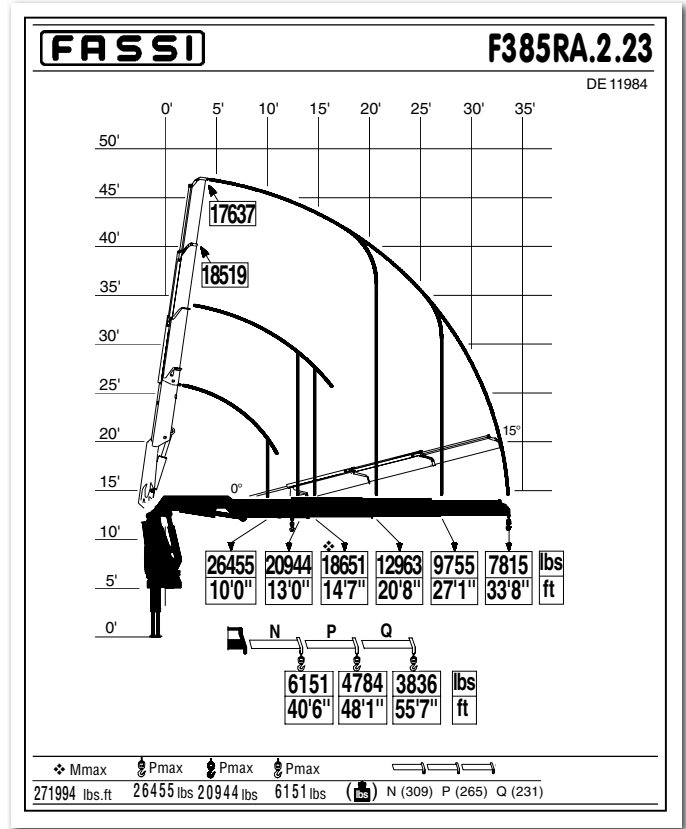
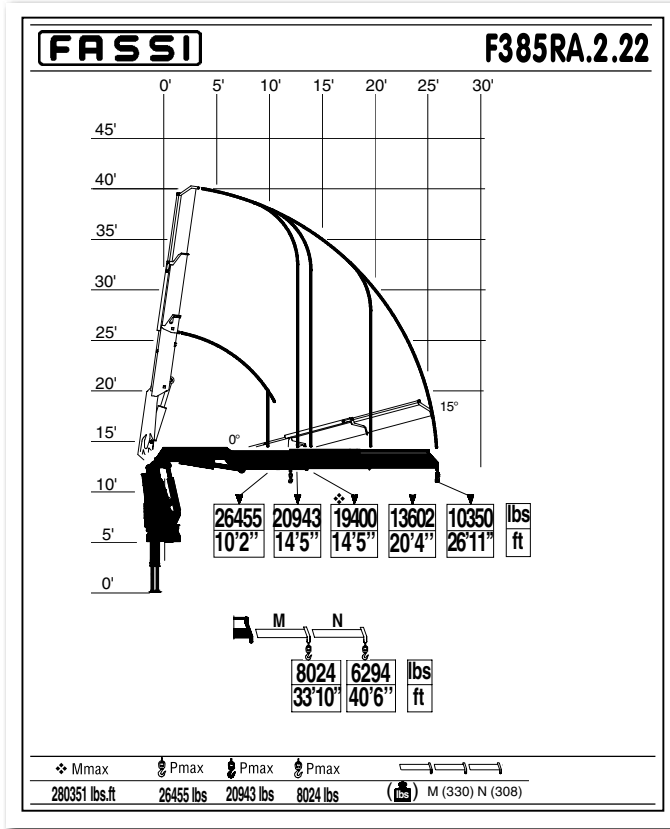



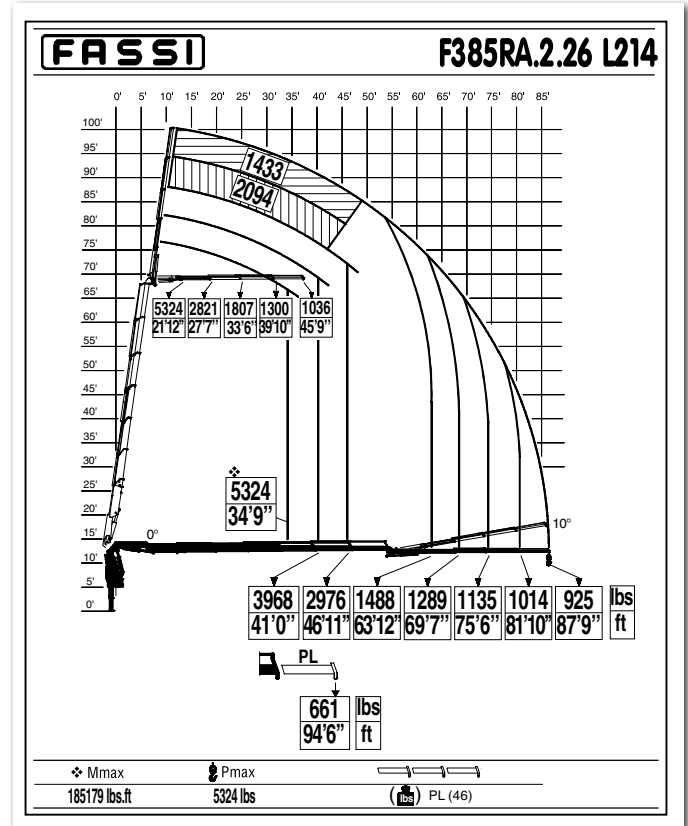
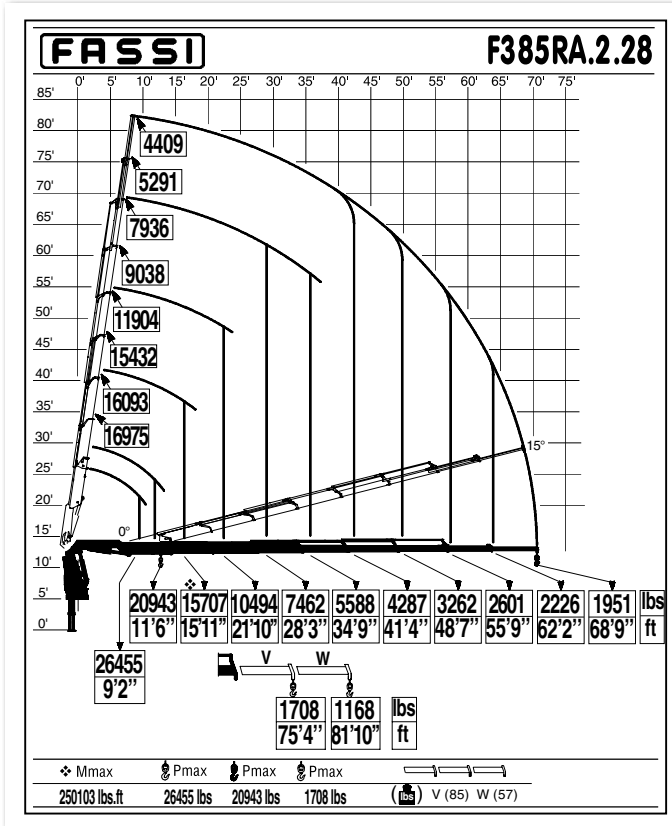
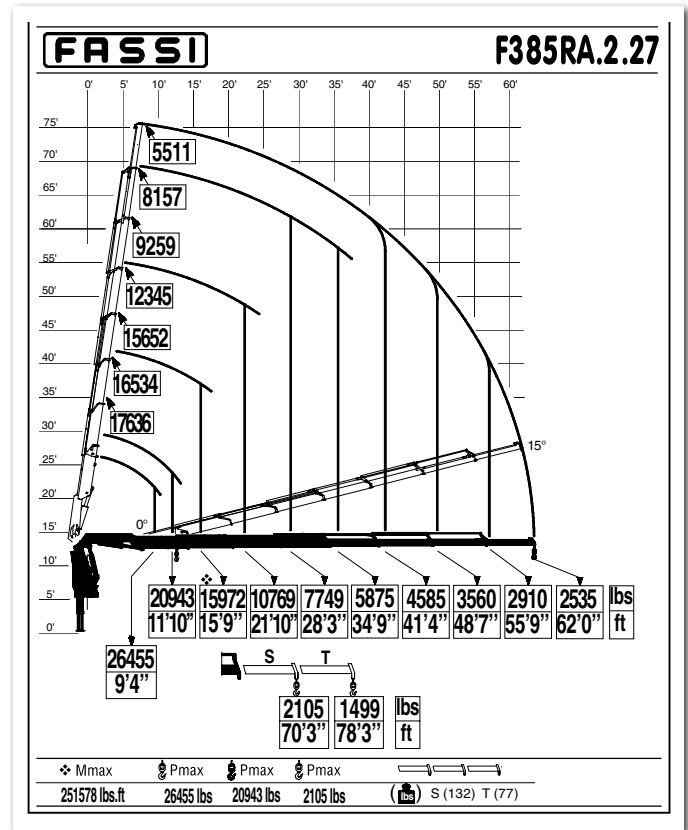
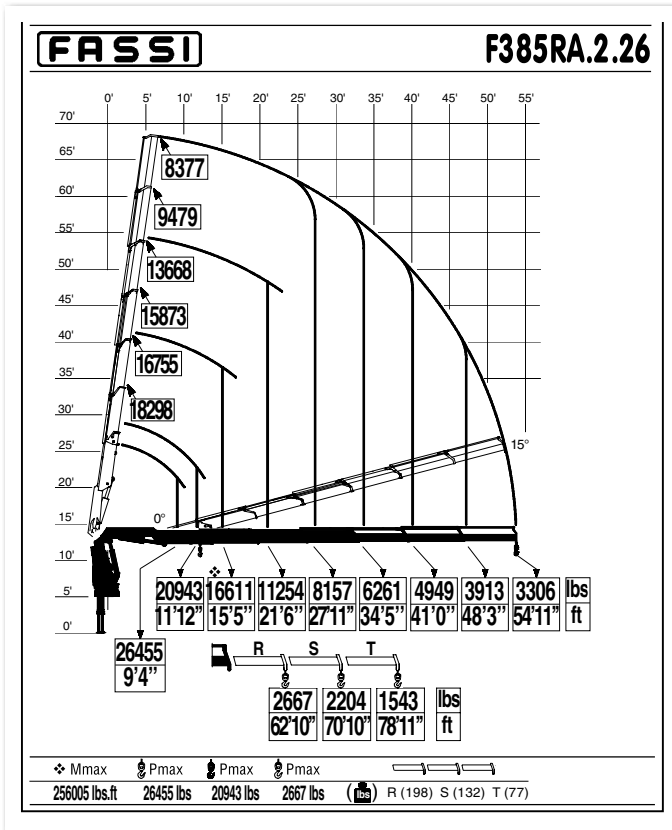









- US** Dynamic load diagrams calculated, tested and certified to lift the loads at the declared reaches
- FR** Diagrammes de charge dynamiques calculés, testés et certifiés pour soulever les charges aux extensions déclarées
- ES** Diagramas de carga dinámicos, calculados, probados y certificados para a elevación de la cargas a los alcances declarados

















- US Dynamic load diagrams calculated, tested and certified to lift the loads at the declared reaches
- FR Diagrammes de charge dynamiques calculés, testés et certifiés pour soulever les charges aux extensions déclarées
- ES Diagramas de carga dinámicos, calculados, probados y certificados para a elevación de la cargas a los alcances declarados

F385A.2

Technical data

lbs/ft												
	lbs.ft	ft	ft	°	lbs.ft	psi	gpm	oil	lbs	ft	ft	ft
F385A.2.22	271599	26'2"	12'5"	430	35044	4500	16 / 21	50	8994	8'3"	4'0"	7'11"
F385A.2.23	260243	32'9"	19'0"	430	35044	4500	16 / 21	50	9545	8'3"	4'2"	7'11"
F385A.2.24	255831	39'10"	25'7"	430	35044	4500	16 / 21	50	10097	8'3"	4'2"	7'11"
F385A.2.25	249177	47'4"	32'9"	430	35044	4500	16 / 21	50	10648	8'3"	4'2"	7'11"
F385A.2.26	245488	54'3"	39'4"	430	35044	4500	16 / 21	50	11199	8'3"	4'2"	7'11"
F385A.2.27	241076	61'10"	46'3"	430	35044	4500	16 / 21	50	11530	8'3"	4'4"	7'11"
F385A.2.28	239629	68'2"	52'11"	430	35044	4500	16 / 21	50	11860	8'3"	4'4"	7'11"
F385A.2.26/L214	245488	87'9"	63'11"	430	35044	4500	16 / 21	50	12852	8'4"	4'9"	8'8"
F385AC.2.24*	257350	34'11"	22'11"	430	35044	4500	16 / 21	50	9898	8'3"	4'2"	7'11"
F385AC.2.25*	254385	41'11"	30'2"	430	35044	4500	16 / 21	50	10449	8'3"	4'2"	7'11"
F385AC.2.26*	247007	49'4"	36'8"	430	35044	4500	16 / 21	50	11000	8'3"	4'2"	7'11"
F385A.2.24/L323*	255831	65'5"	41'4"	430	35044	4500	16 / 21	50	11750	8'4"	4'9"	8'6"
F385A.2.24/L324*	255831	71'8"	47'2"	430	35044	4500	16 / 21	50	11970	8'4"	4'9"	8'6"
F385A.2.25/L323*	249177	72'8"	48'6"	430	35044	4500	16 / 21	50	12301	8'4"	4'9"	8'6"
F385A.2.25/L324*	249177	78'10"	54'5"	430	35044	4500	16 / 21	50	12522	8'4"	4'9"	8'6"
F385A.2.26/L212*	245488	74'5"	51'0"	430	35044	4500	16 / 21	50	12522	8'4"	4'9"	8'8"
F385A.2.26/L213*	245488	81'0"	57'4"	430	35044	4500	16 / 21	50	12698	8'4"	4'9"	8'8"
F385A.2.27/L153*	241076	87'3"	63'7"	430	35044	4500	16 / 21	50	12830	8'4"	4'9"	8'8"
F385A.2.27/L154*	241076	93'11"	70'0"	430	35044	4500	16 / 21	50	12985	8'4"	4'9"	8'8"
F385AC.2.24/L323*	257350	60'2"	38'4"	430	35044	4500	16 / 21	50	11552	8'4"	4'9"	8'6"
F385AC.2.24/L324*	257350	66'3"	44'7"	430	35044	4500	16 / 21	50	11772	8'4"	4'9"	8'6"
F385AC.2.25/L323*	254385	67'3"	45'11"	430	35044	4500	16 / 21	50	12103	8'4"	4'9"	8'6"
F385AC.2.25/L324*	254385	73'5"	51'10"	430	35044	4500	16 / 21	50	12323	8'4"	4'9"	8'6"

*US / The range of versions available also includes F385AC.2.24 , F385AC.2.25 ,F385AC.2.26 , F385A.2.24 L323/L324 , F385A.2.25 L323/L324 , F385A.2.26 L212/L213 , F385A.2.27 L153/L154 , F385AC.2.24 L323/L324 , F385AC.2.25 L323/L324 to see the load diagram go to fassitech.com: - FR / La gamme de versions disponibles comprend aussi F385AC.2.24 , F385AC.2.25 ,F385AC.2.26 , F385A.2.24 L323/L324 , F385A.2.25 L323/L324 , F385A.2.26 L212/L213 , F385A.2.27 L153/L154 , F385AC.2.24 L323/L324 , F385AC.2.25 L323/L324 , pour voir le diagramme de charge consulter le site Internet fassitech.com - ES / La gama de versiones disponibles también incluye F385AC.2.24 , F385AC.2.25 ,F385AC.2.26 , F385A.2.24 L323/L324 , F385A.2.25 L323/L324 , F385A.2.26 L212/L213 , F385A.2.27 L153/L154 , F385AC.2.24 L323/L324 F385AC.2.25 L323/L324 , para ver el diagrama de carga visitar el sitio web fassitech.com

												
	Lifting capacity	Standard reach	Hydraulic extension	Rotation	Rotation torque	Working pressure	Pump capacity	Oil tank capacity	Crane weight	Crane width	Installation width	Crane height
	Capacité de levage	Bras standard	Extension hydraulique	Rotation	Couple de rotation	Pression d'utilisation	Débit de la pompe	Capacité du réservoir d'huile	Poids de la grue	Largeur de la grue	Largeur de montage	Hauteur de la grue
	Capacidad de elevación	Brazo standard	Extensión hidráulica	Ángulo de rotación	Potencia de rotación	Presión de trabajo	Capacidad de la bomba	Capacidad depósito aceite	Peso de la grúa	Anchura de la grúa	Anchura de montaje	Altura de la grúa

F385A e-dynamic

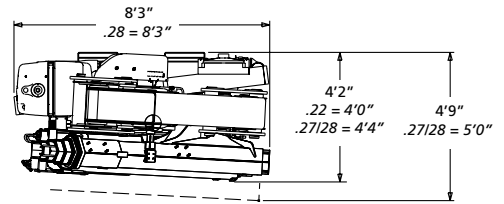
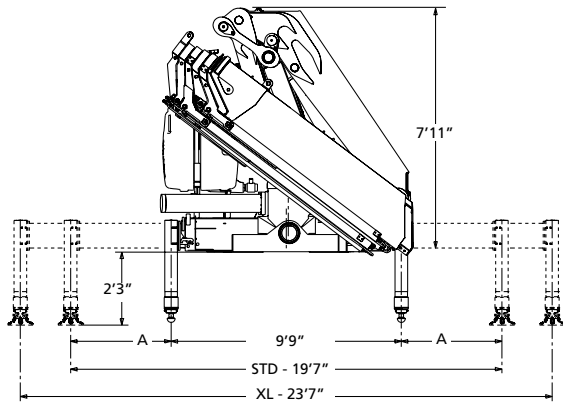

	STD	XL
A	6'0"	8'0"

L SERIE

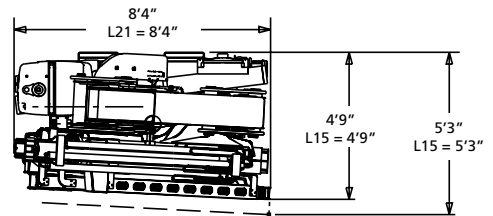
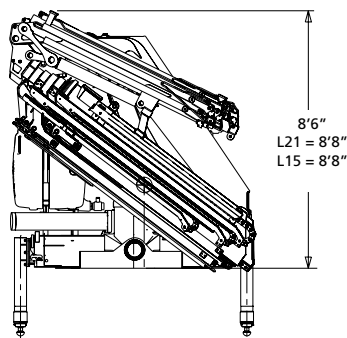

L153	1058 lbs	L154	1212 lbs	L212	1102 lbs	L213	1278 lbs	L214	1432 lbs	L323	1499 lbs	L324	780 lbs
NL	52 lbs	PL	46 lbs	ML	97 lbs	NL	63 lbs	PL	46 lbs	NL	110 lbs	NL	50 lbs
PL	46 lbs			NL	63 lbs	PL	46 lbs			PL	50 lbs	PL	32 lbs
				PL	46 lbs								

F385A e-dynamic

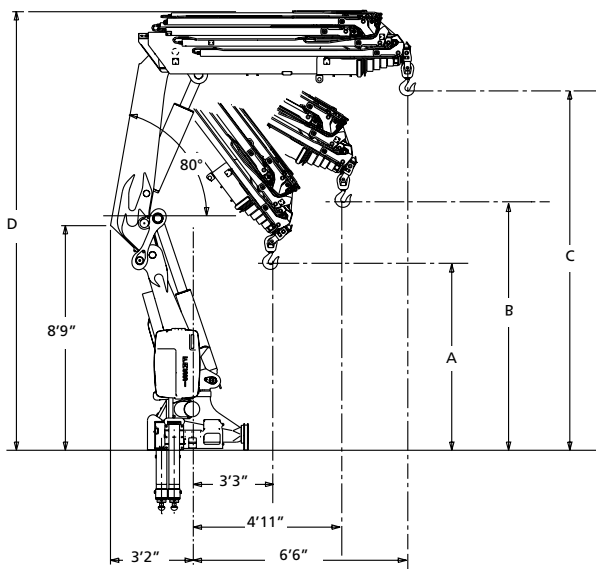

	A	B	C	D
F385A.2.22	7'11"	9'4"	12'2"	16'7"
F385A.2.23	7'8"	8'11"	11'5"	16'7"
F385A.2.24	7'4"	8'7"	10'10"	16'9"
F385A.2.25	7'1"	8'3"	10'4"	16'9"
F385A.2.26	6'9"	7'11"	9'10"	16'11"
F385A.2.27	6'6"	7'7"	9'4"	16'11"
F385A.2.28	6'4"	7'5"	9'2"	16'11"



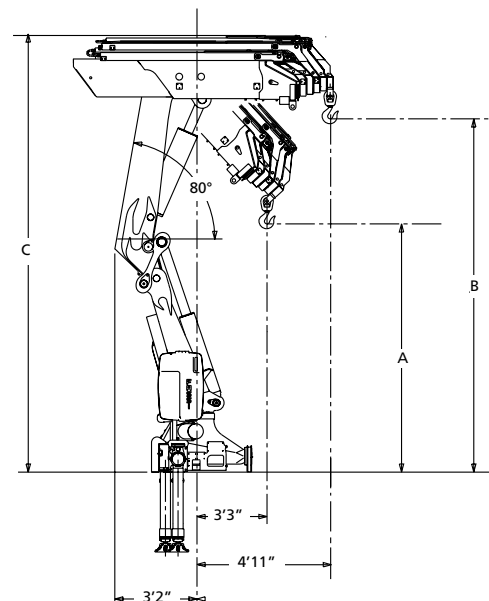









F385AC e-dynamic

















	A	B	C
F385AC.2.24	10'9"	-	16'9"
F385AC.2.25	10'5"	13'7"	16'9"
F385AC.2.26	10'0"	12'6"	16'11"

F385RA.2

Technical data

lbs/ft												
	lbs.ft	ft	ft	°	lbs.ft	psi	gpm	oil	lbs	ft	ft	ft
F385RA.2.22	280206	26'8"	12'5"	360 CONTINUOUS	32535	4500	16 / 21	53	8994	8'1"	4'5"	8'0"
F385RA.2.23	272033	33'5"	19'0"	360 CONTINUOUS	32535	4500	16 / 21	53	9545	8'1"	4'7"	8'0"
F385RA.2.24	267621	40'4"	25'7"	360 CONTINUOUS	32535	4500	16 / 21	53	10097	8'1"	4'7"	8'0"
F385RA.2.25	261039	47'10"	32'9"	360 CONTINUOUS	32535	4500	16 / 21	53	10648	8'1"	4'7"	8'0"
F385RA.2.26	255831	54'9"	39'4"	360 CONTINUOUS	32535	4500	16 / 21	53	11199	8'2"	4'7"	8'0"
F385RA.2.27	251419	62'4"	46'3"	360 CONTINUOUS	32535	4500	16 / 21	53	11530	8'2"	4'9"	8'0"
F385RA.2.28	249972	68'6"	52'11"	360 CONTINUOUS	32535	4500	16 / 21	53	11860	8'3"	4'9"	8'0"
F385RA.2.26/L214	255831	87'9"	63'3"	360 CONTINUOUS	32535	4500	16 / 21	53	12852	8'4"	5'2"	8'9"
F385RAC.2.24*	267621	35'1"	22'11"	360 CONTINUOUS	32535	4500	16 / 21	53	9898	8'1"	4'7"	8'0"
F385RAC.2.25*	264728	42'7"	29'6"	360 CONTINUOUS	32535	4500	16 / 21	53	10449	8'1"	4'7"	8'0"
F385RAC.2.26*	257350	49'6"	36'8"	360 CONTINUOUS	32535	4500	16 / 21	53	11000	8'2"	4'7"	8'0"
F385RA.2.24/L323*	267621	65'11"	41'4"	360 CONTINUOUS	32535	4500	16 / 21	53	11750	8'4"	5'2"	8'7"
F385RA.2.24/L324*	267621	72'8"	47'2"	360 CONTINUOUS	32535	4500	16 / 21	53	11970	8'4"	5'2"	8'7"
F385RA.2.25/L323*	261039	73'1"	48'6"	360 CONTINUOUS	32535	4500	16 / 21	53	12301	8'4"	5'2"	8'7"
F385RA.2.25/L324*	261039	79'4"	54'5"	360 CONTINUOUS	32535	4500	16 / 21	53	12522	8'4"	5'2"	8'7"
F385RA.2.26/L212*	255831	74'11"	51'0"	360 CONTINUOUS	32535	4500	16 / 21	53	12522	8'4"	5'2"	8'9"
F385RA.2.26/L213*	255831	81'6"	57'4"	360 CONTINUOUS	32535	4500	16 / 21	53	12698	8'4"	5'2"	8'9"
F385RA.2.27/L153*	251419	87'11"	63'7"	360 CONTINUOUS	32535	4500	16 / 21	53	12830	8'4"	5'5"	8'9"
F385RA.2.27/L154*	251419	94'1"	69'6"	360 CONTINUOUS	32535	4500	16 / 21	53	12985	8'4"	5'5"	8'9"
F385RAC.2.24/L323*	267621	60'8"	38'8"	360 CONTINUOUS	32535	4500	16 / 21	53	11552	8'4"	5'2"	8'6"
F385RAC.2.24/L324*	267621	66'9"	44'7"	360 CONTINUOUS	32535	4500	16 / 21	53	11772	8'4"	5'2"	8'6"
F385RAC.2.25/L323*	264728	67'10"	45'11"	360 CONTINUOUS	32535	4500	16 / 21	53	12103	8'4"	5'2"	8'6"
F385RAC.2.25/L324*	264728	74'1"	51'10"	360 CONTINUOUS	32535	4500	16 / 21	53	12323	8'4"	5'2"	8'6"

*US / The range of versions available also includes F385RAC.2.24 , F385RAC.2.25 ,F385RAC.2.26 , F385RA.2.24 L323/L324 , F385RA.2.25 L323/L324 , F385RA.2.26 L212/L213 , F385RA.2.27 L153/L154 , F385RAC.2.24 L323/L324 , F385RAC.2.25 L323/L324 to see the load diagram go to fassitech.com: - FR / La gamme de versions disponibles comprend aussi F385RAC.2.24 , F385RAC.2.25 ,F385RAC.2.26 , F385RA.2.24 L323/L324 , F385RA.2.25 L323/L324 , F385RA.2.26 L212/L213 , F385RA.2.27 L153/L154 , F385RAC.2.24 L323/L324 , F385RAC.2.25 L323/L324 , pour voir le diagramme de charge consulter le site Internet fassitech.com - ES / La gama de versiones disponibles también incluye F385RAC.2.24 , F385RAC.2.25 ,F385RAC.2.26 , F385RA.2.24 L323/L324 , F385RA.2.25 L323/L324 , F385RA.2.26 L212/L213 , F385RA.2.27 L153/L154 , F385RAC.2.24 L323/L324 F385RAC.2.25 L323/L324 , para ver el diagrama de carga visitar el sitio web fassitech.com

												
	Lifting capacity	Standard reach	Hydraulic extension	Rotation	Rotation torque	Working pressure	Pump capacity	Oil tank capacity	Crane weight	Crane width	Installation width	Crane height
	Capacité de levage	Bras standard	Extension hydraulique	Rotation	Couple de rotation	Pression d'utilisation	Débit de la pompe	Capacité du réservoir d'huile	Poids de la grue	Largeur de la grue	Largeur de montage	Hauteur de la grue
	Capacidad de elevación	Brazo standard	Extensión hidráulica	Ángulo de rotación	Potencia de rotación	Presión de trabajo	Capacidad de la bomba	Capacidad depósito aceite	Peso de la grúa	Anchura de la grúa	Anchura de montaje	Altura de la grúa

F385RA e-dynamic

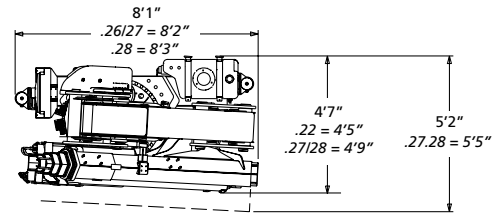
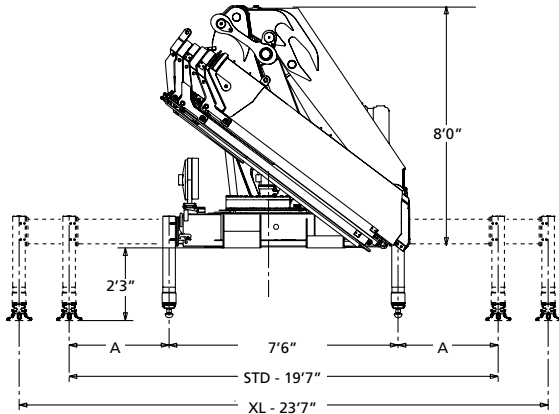

	STD	XL
A	6'0"	8'0"

L SERIE

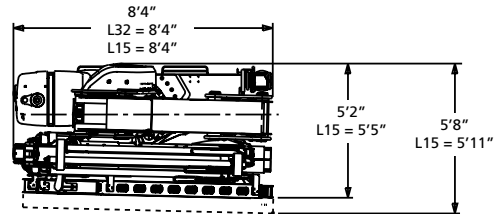
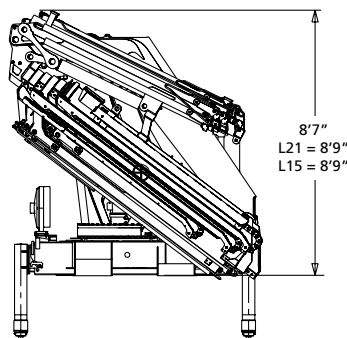

L153	1058 lbs	L154	1212 lbs	L212	1102 lbs	L213	1278 lbs	L214	1432 lbs	L323	1499 lbs	L324	1719 lbs
NL	52 lbs	PL	46 lbs	ML	97 lbs	NL	63 lbs	PL	46 lbs	NL	110 lbs	NL	110 lbs
PL	46 lbs			NL	63 lbs	PL	46 lbs			PL	70 lbs	PL	70 lbs
				PL	46 lbs								

F385RA e-dynamic

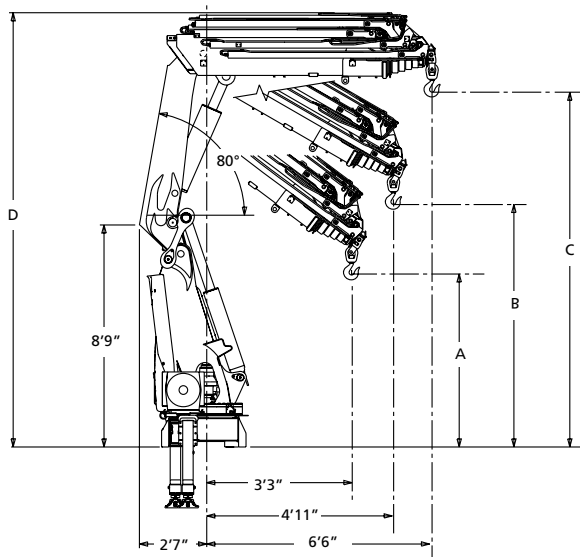

	A	B	C	D
F385RA.2.22	7'9"	8'10"	10'11"	16'7"
F385RA.2.23	7'5"	8'6"	10'5"	16'7"
F385RA.2.24	7'2"	8'2"	9'11"	16'10"
F385RA.2.25	6'11"	7'10"	9'6"	16'10"
F385RA.2.26	6'7"	7'6"	9'1"	17'0"
F385RA.2.27	6'4"	7'3"	8'8"	17'0"
F385RA.2.28	6'2"	7'1"	8'5"	17'0"

F385RAC e-dynamic

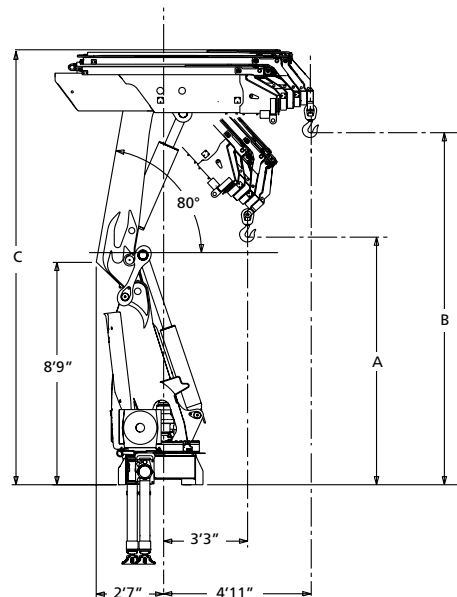

	A	B	C
F385RAC.2.24	10'3"	12'6"	16'10"
F385RAC.2.25	10'0"	11'11"	16'10"
F385RAC.2.26	9'8"	11'5"	17'0"



US

ELECTRONIC DOCUMENTATION

All documentation related to the "Techno chips" and the crane is available in electronic format. Require all information you may need directly to your Fassi dealer or download them from the internet site: www.fassi.com.

FR

DOCUMENTATION ELECTRONIQUE

Toutes les informations relatives aux "Techno chips" et aux grues sont disponibles sous format électronique. Elles peuvent être demandées aux concessionnaires Fassi ou téléchargées sur le site www.fassi.com.

ES

DOCUMENTACION ELECTRÓNICA

Toda la información relativa a los "techno chips" y a las grúas está disponible en formato electrónico. Se puede solicitar directamente a los concesionarios Fassi, o bien descargarse on line desde la web www.fassi.com.



FASSI

www.fassi.com

FASSI GRU S.p.A.
Via Roma, 110
24021 Albino (Bergamo) ITALY
Tel- +39 035 776400
Fax +39 035 755020
<http://www.fassi.com>
E-mail: fassi@fassi.com

COMPANY
WITH QUALITY MANAGEMENT
SYSTEM CERTIFIED BY DNV
= ISO 9001:2008 =